

Common Mode Choke

CHOK4532 SERIES

PRODUCT CATALOG



寶仁弘電子有限公司 Prosperity Electronic Co., Limited

EML: brh@baorenhong.com Web: www.baorenhong.com

TEL: 0755-29687188 FAX: 0755-29688152

深圳市寶安區福永鎮立新二路天佑創客產業園

TEL: 0512-36878535 FAX: 0512-36878435

江蘇省昆山市花橋鎮綠地大道1325號

Common Mode Choke

◎ Product introduction 產品介紹

- Excellent solderability and heat resistance for either flow or reflow soldering

良好的可焊性和耐焊性

- High common mode impedance at high frequency

高頻下有較高共模阻抗

- Excellent noise suppression performance

良好的噪聲抑制性能

- Terminal electrode has been electroplated, suitable flow soldering, reflow soldering an arbitrary welding method

端子電極已經過電鍍，可適用流動焊接，回流焊接任意一種焊接工法



◎ Product application 產品應用

- Ideally used in digital TVS, DVD recorders and liquid crystal projectors PCS.USD2.0、IEEE1394 connected local area network interface.

用於數字電視、DVD和液晶投影機及個人計算機及USB2.0，IEEE1394等局域網接口。

◎ Product Identification 產品標識

CHOK 4532 S 901 A 23 T

CHOK-----Series name 系列名稱

4532-----Dimension 產品尺寸

S-----Material code 材料代碼

901-----Impedance 阻抗值【901=900Ω】

A-----High current 耐大電流

23-----Current value 電流值

T-----Taping 編帶盤裝

SMD Common Mode Chocke

◎Shape&Dimensions 形狀與尺寸:

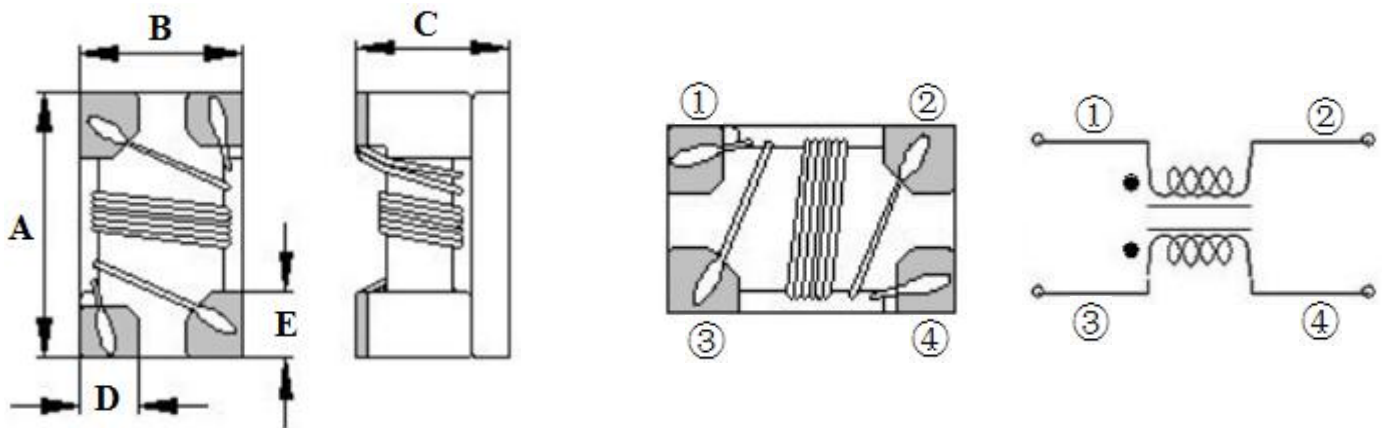

unit:mm

PART NAUMBER	A	B	C	D	E	CHIPS REEL
1210	1.2±0.20	1.0±0.30	1.0±0.30	0.38 Typ	0.36 Typ	4K
2012	2.0±0.20	1.2±0.20	1.2±0.20	0.40 Typ	0.45 Typ	3K
3216	3.2±0.20	1.6±0.20	2.0±0.20	0.60 Typ	0.60 Typ	2K
3225	3.2±0.20	2.5±0.20	2.2±0.20	0.90 Typ	0.80 Typ	2K
4525	4.8±0.20	2.8±0.20	2.2±0.20	0.75 Typ	0.75 Typ	2K
4528/4532	4.5±0.20	3.2±0.20	2.8±0.20	1.00 Typ	1.00 Typ	0.5K

◎Recommender Land Pattern 推薦焊盤布局:

unit:mm

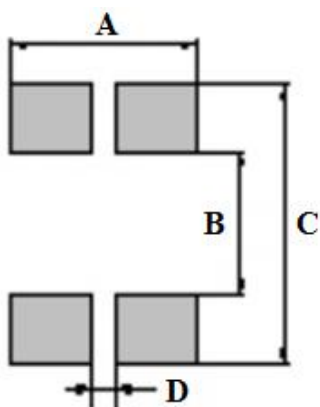

PART NAUMBER	A	B	C	D
1210	1.20 Typ	0.60 Typ	1.50 Typ	0.30 Typ
2012	1.20 Typ	0.80 Typ	2.60 Typ	0.40 Typ
3216	1.60 Typ	1.60 Typ	3.70 Typ	0.40 Typ
3225	3.50 Typ	1.60 Typ	4.40 Typ	0.60 Typ
4525	2.95 Typ	3.50 Typ	6.00 Typ	1.05 Typ
4528/4532	3.60 Typ	2.10 Typ	4.90 Typ	0.40 Typ

SMD Common Mode Chocke

© Detailed specifications and parameters are introduced

詳細規格及參數介紹

ORDERING CORE	Common Mode Impedance (Ω)		Test Frequency (MHz)	DC Resistance (Ω)MAX	Rated Current (mA)MAX
	MIN	Typ.			
CHOK4532S800A30T	60	80	100	0.050	3000
CHOK4532S900A40T	68	90	100	0.050	4000
CHOK4532S121A30T	90	120	100	0.050	3000
CHOK4532S201A15T	150	200	100	0.100	1500
CHOK4532S231A35T	173	230	100	0.050	3500
CHOK4532S421A32T	300	420	100	0.055	3200
CHOK4532S601A15T	450	600	100	0.240	1500
CHOK4532S601A25T	450	600	100	0.060	2500
CHOK4532S801A10T	600	800	100	0.240	1000
CHOK4532S901A23T	650	900	100	0.070	2300
CHOK4532S142A20T	1000	1400	100	0.100	2000
CHOK4532S282A09T	2100	2800	100	0.350	900

SMD Common Mode Chocke

◎ Test curve of reference as follows

測試曲線參考如下：

COMMON MODE NORMAL MODE

CHOK4532S900A40T

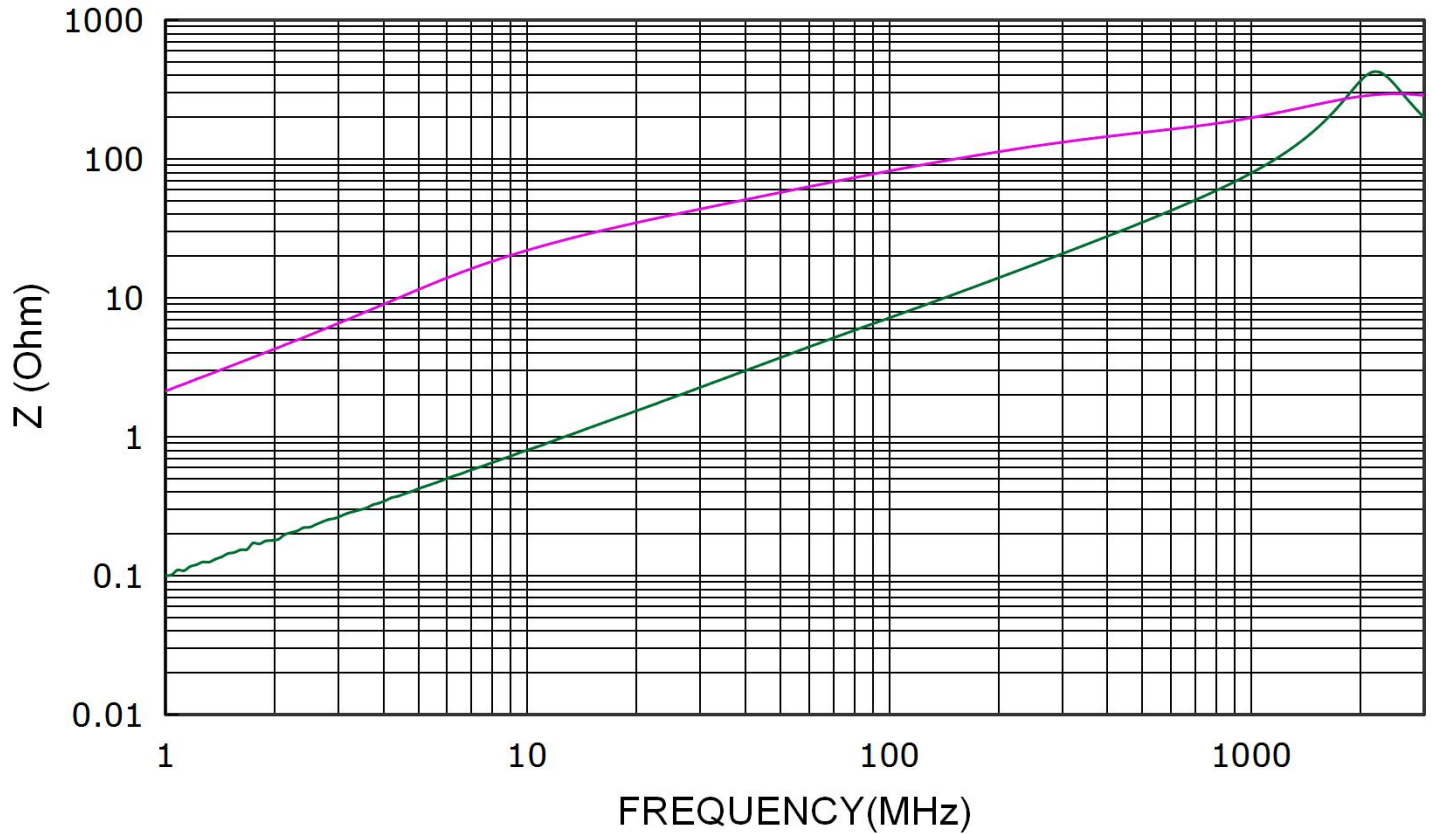

SMD Common Mode Chocke

CHOK4532S121A30T

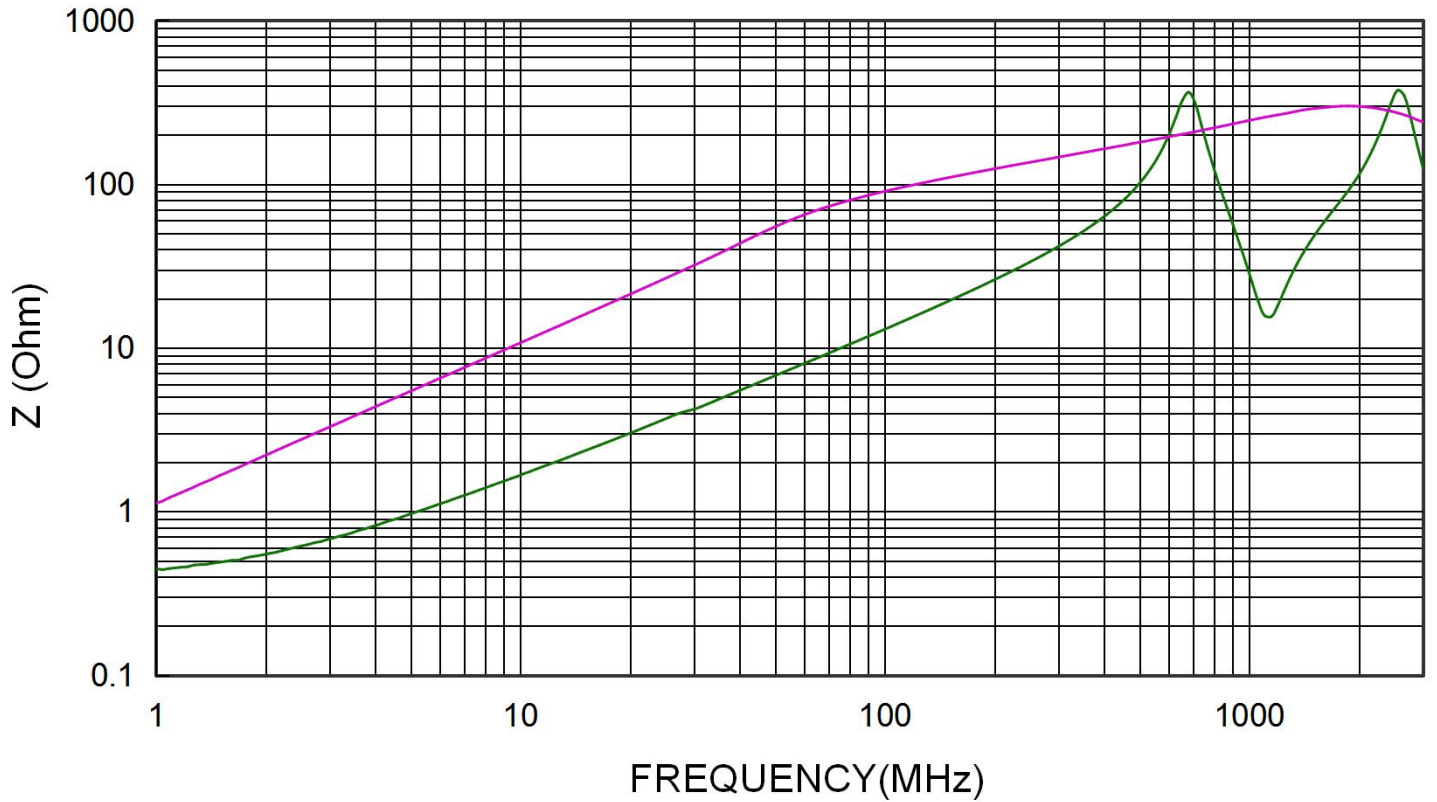

CHOK4532S201A15T

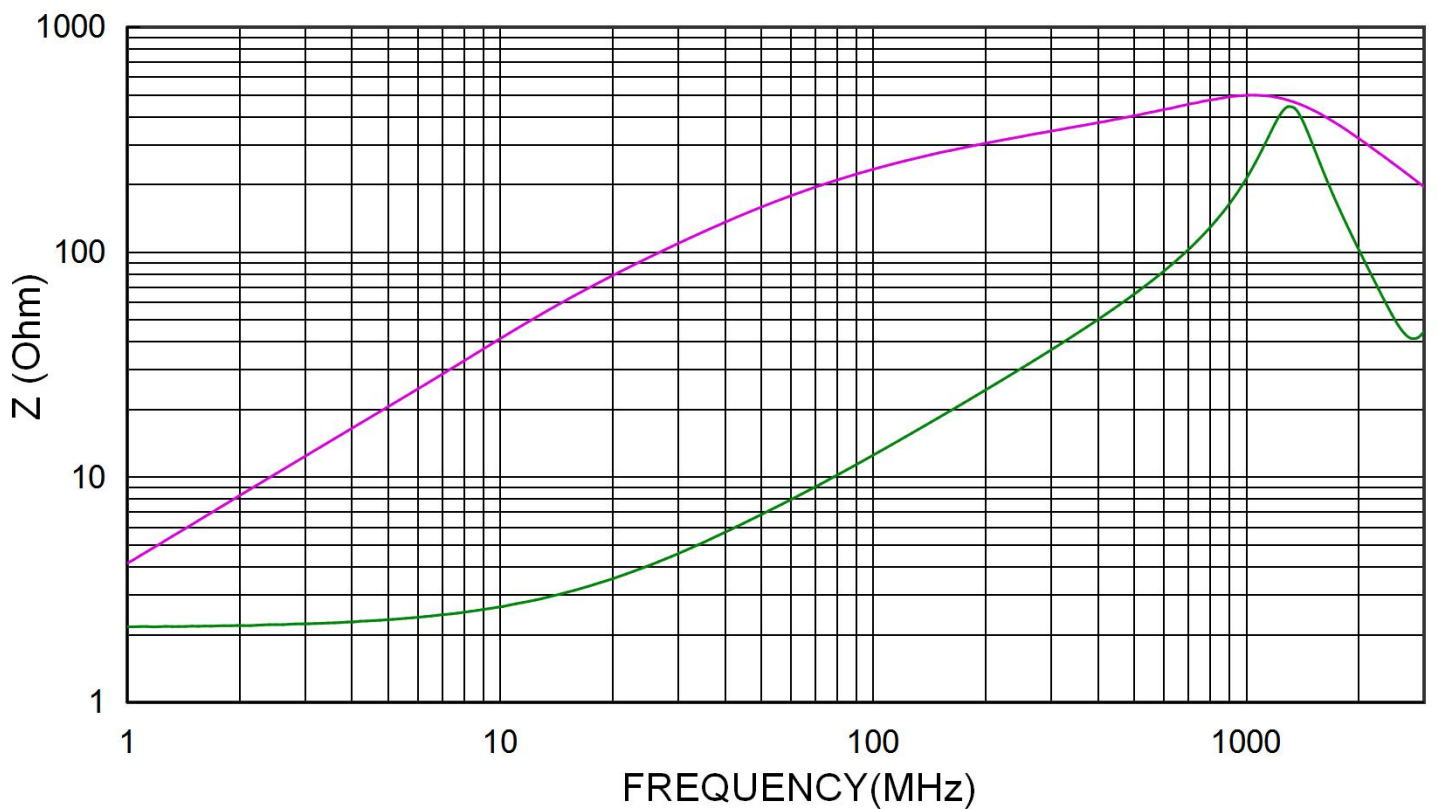

SMD Common Mode Chocke

CHOK4532S231A35T

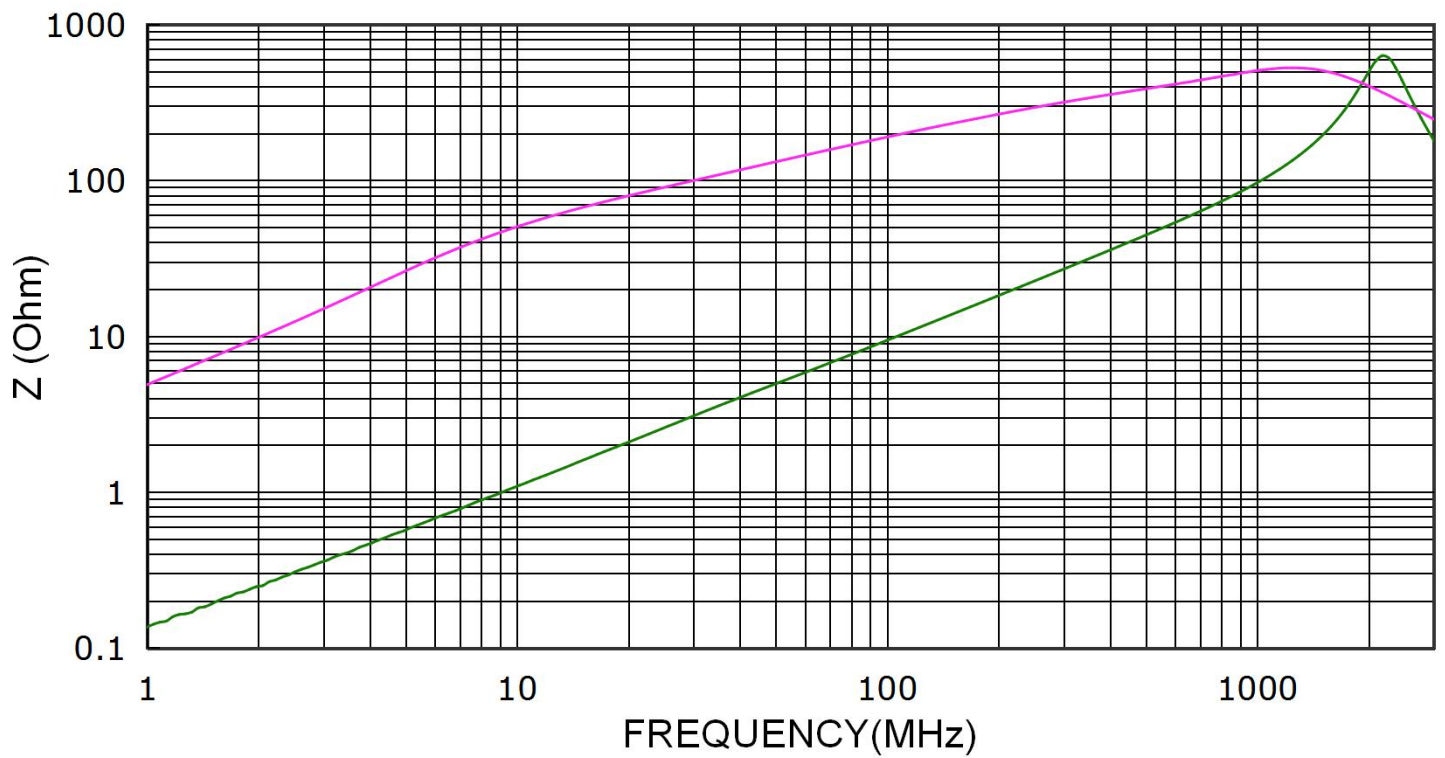

CHOK4532S421A32T

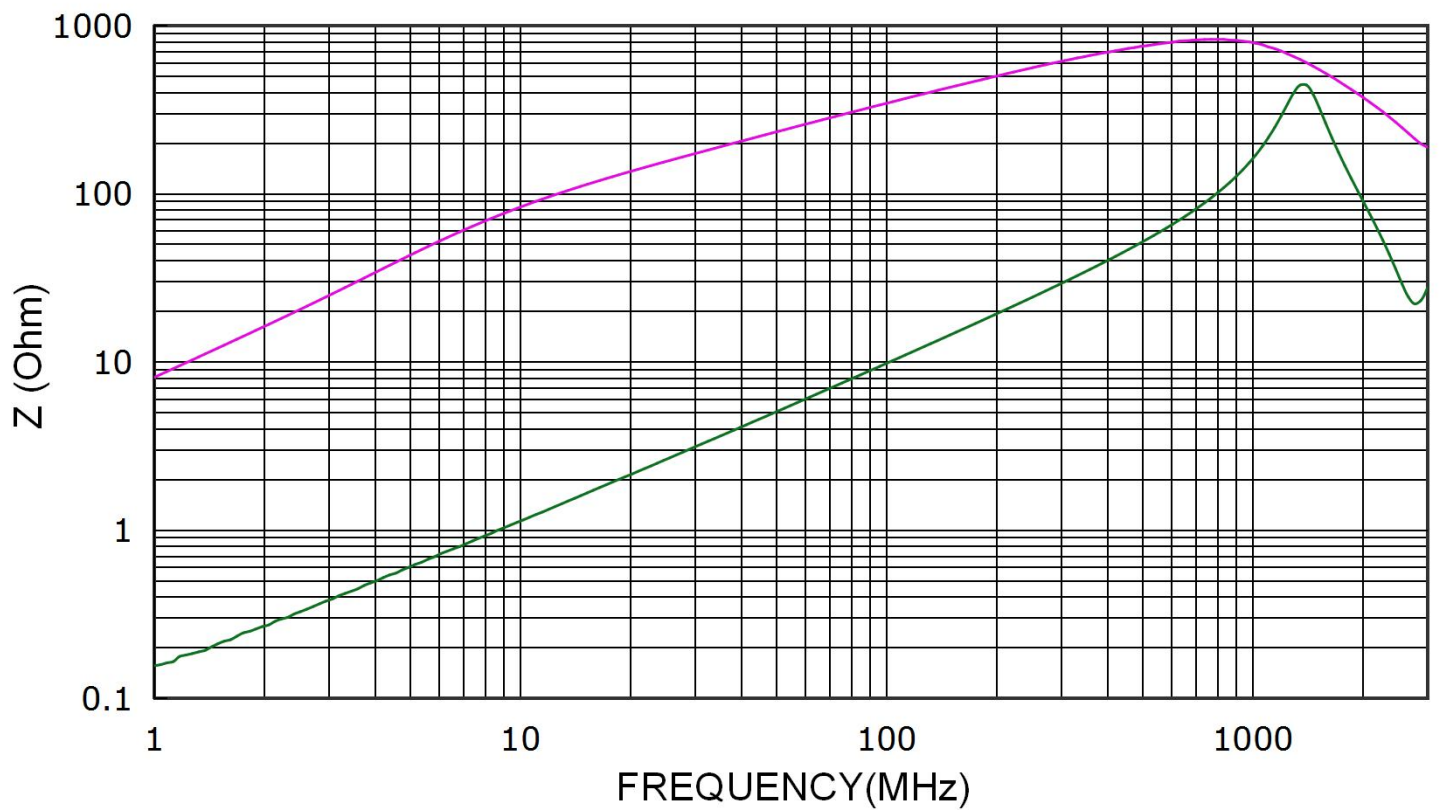

SMD Common Mode Chocke

CHOK4532S601A15T

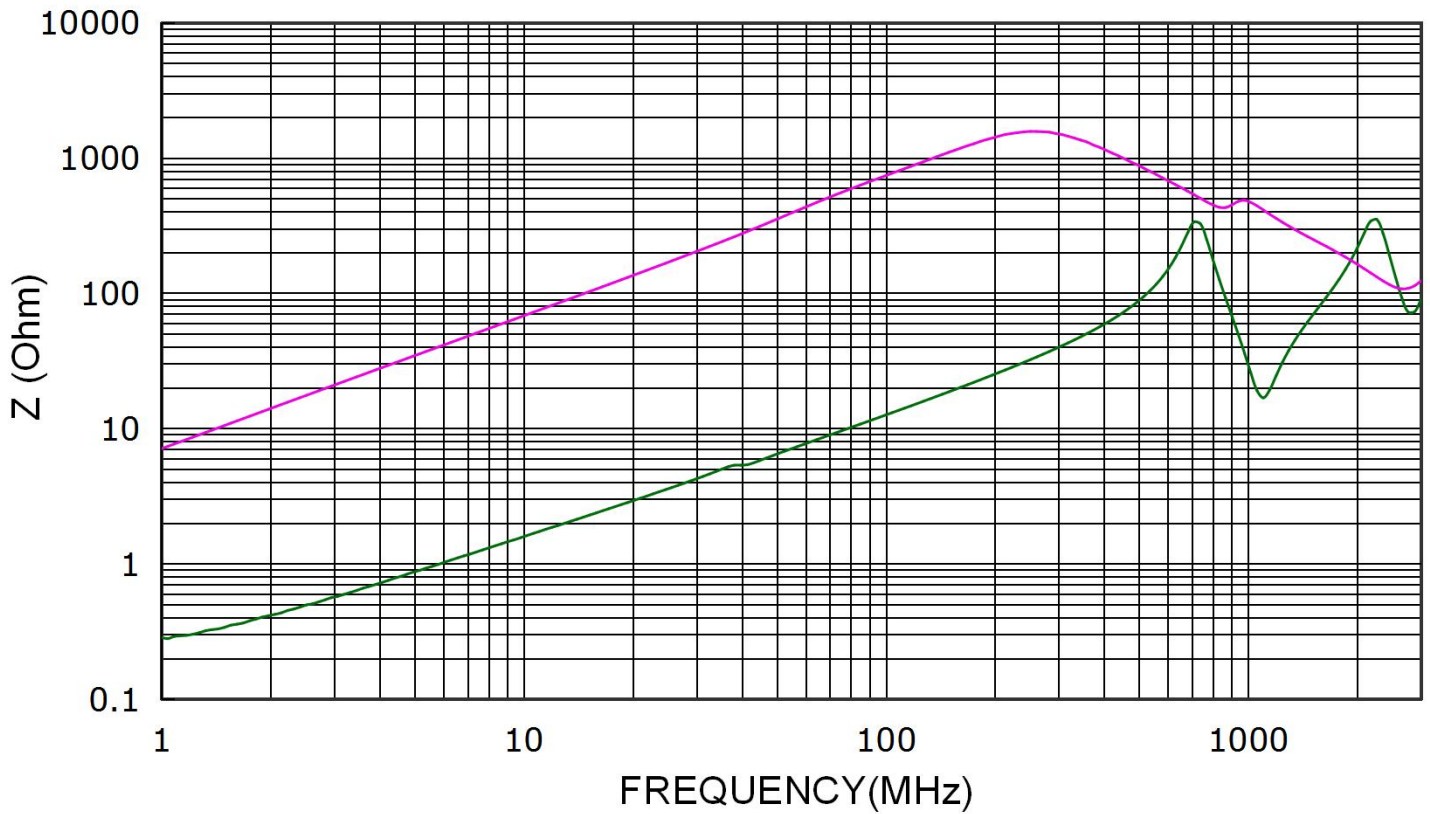

CHOK4532S601A25T

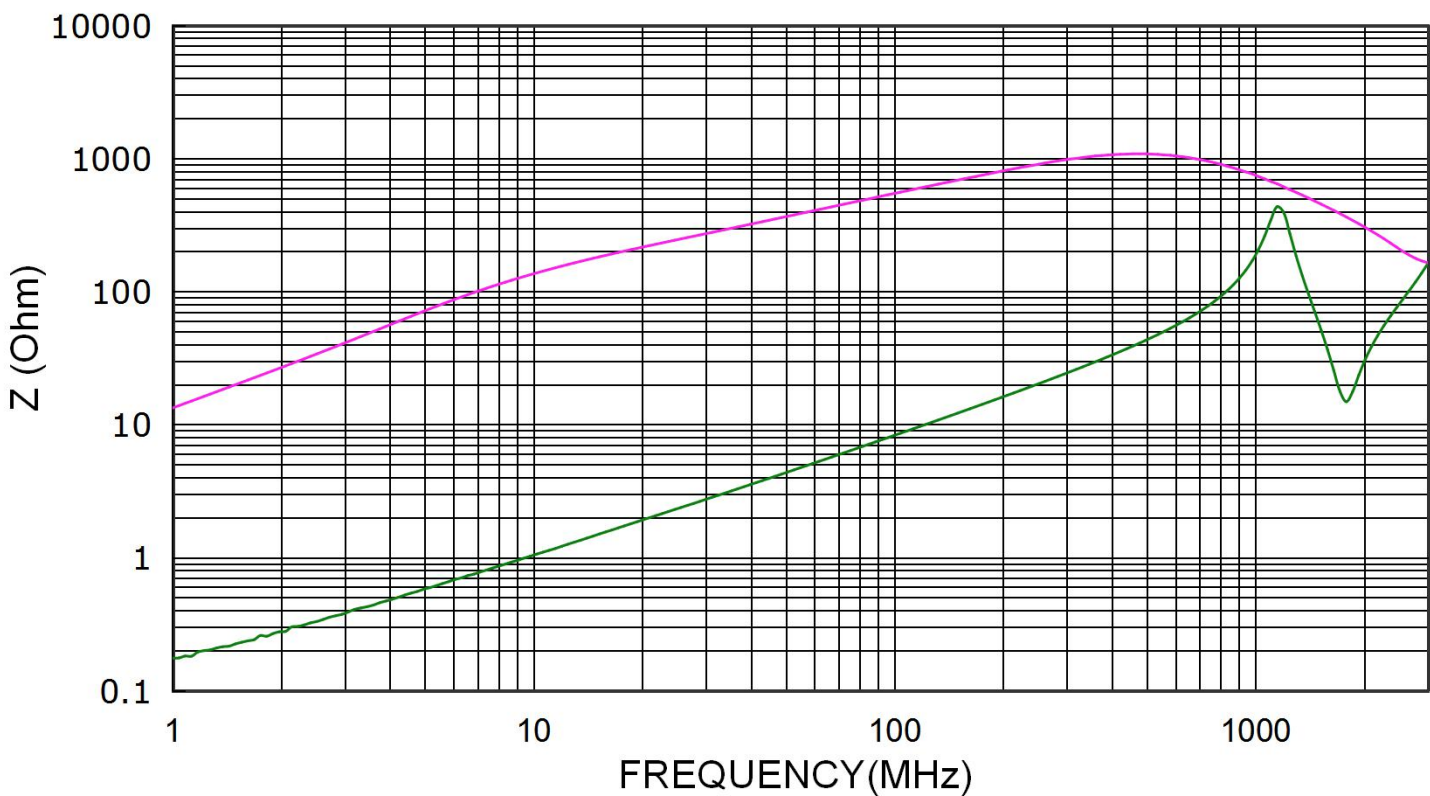

SMD Common Mode Chocke

CHOK4532S801A10T

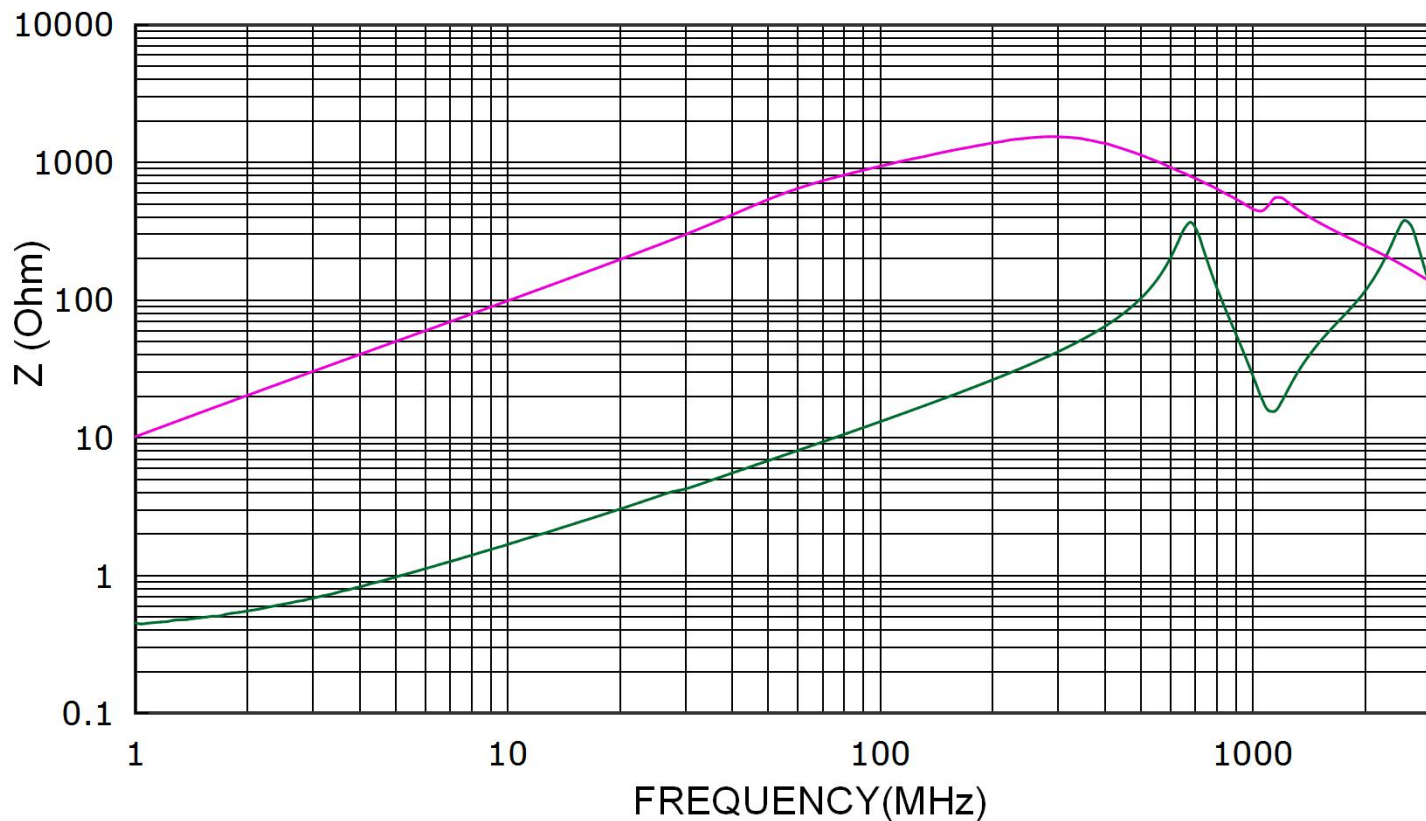

CHOK4532S901A23T

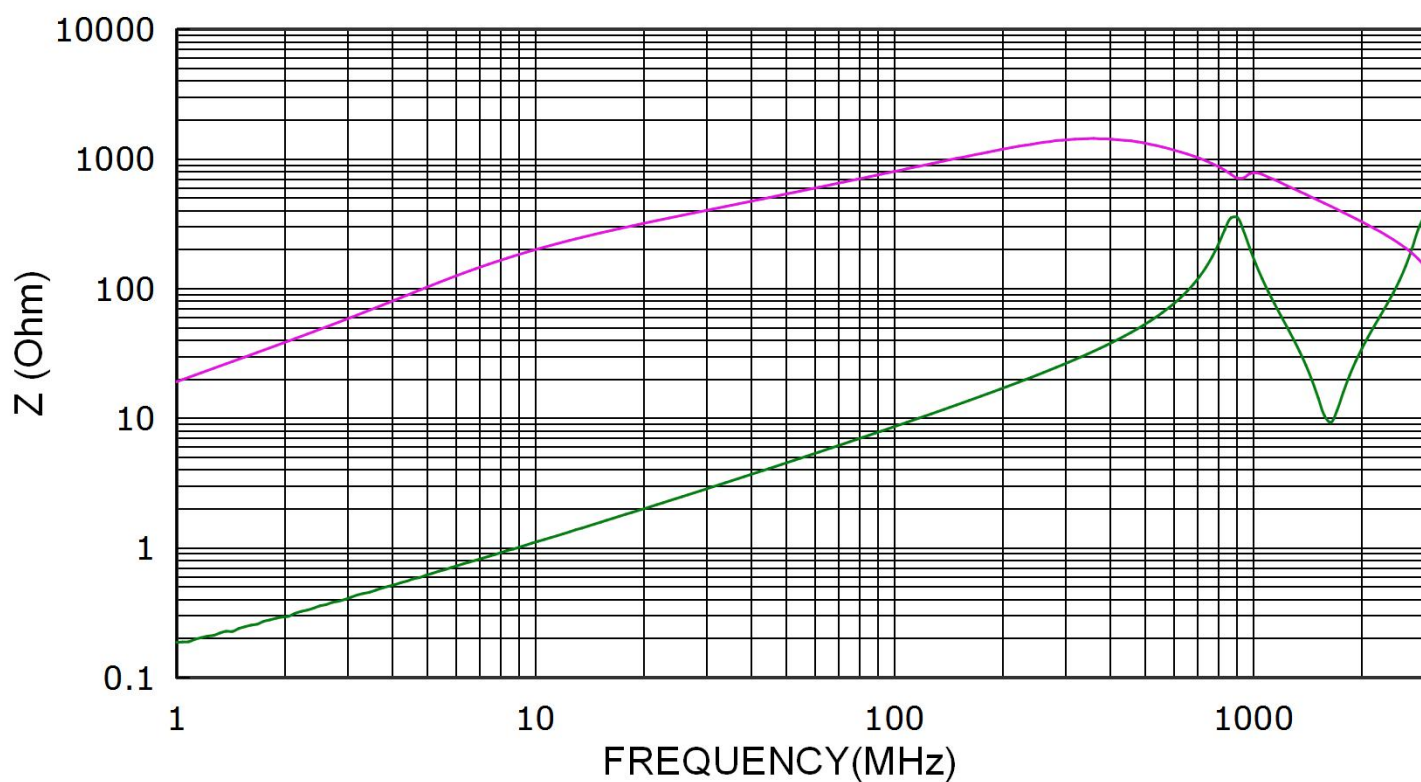

SMD Common Mode Chocke

CHOK4532S142A20T

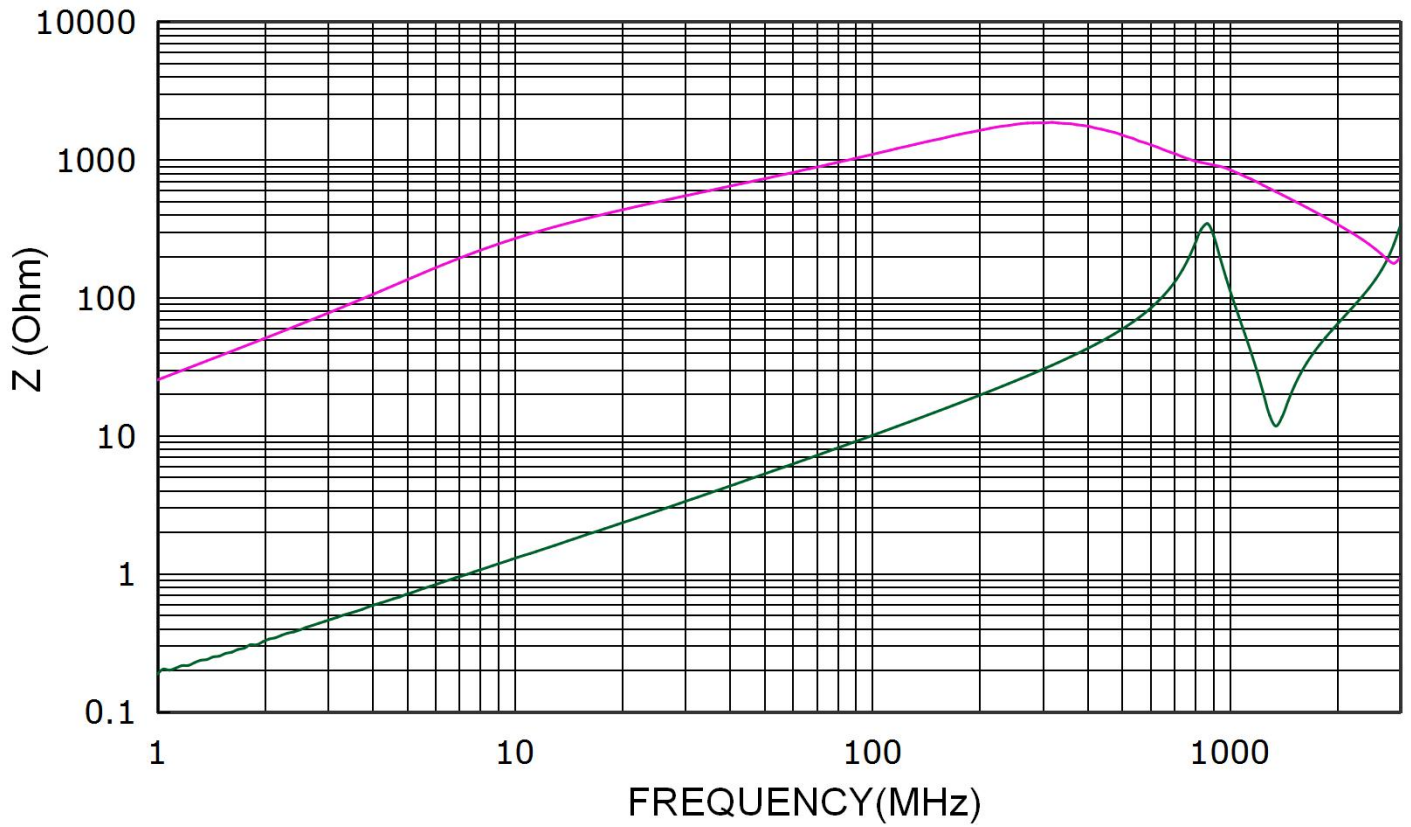

CHOK4532S282A09T

